

FUNCTIONS OF VALVE POSITIONS

Valve Position	Function
FILTER	Normal Filtration and Vacuuming
BACKWASH	Cleaning Filter by reversing the flow
RINSE	Used after backwash to flush dirt from valve
WASTE	By-passes filter, used for vacuuming to waste or lowering water level
RECIRCULATE	By-passes filter for circulating water to pool
CLOSED	Shuts off all flow to filter or pool

FILTER

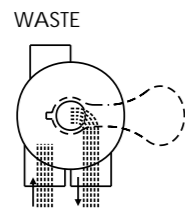

IN FLOW OUT FLOW

WASTE

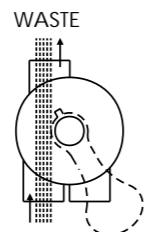

IN FLOW OUT FLOW

CLOSED

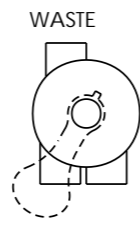

IN FLOW OUT FLOW

BACKWASH

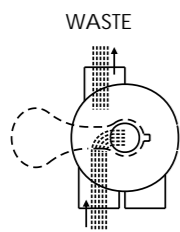

IN FLOW OUT FLOW

RINSE

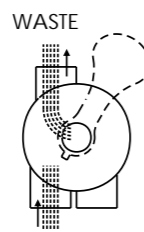

IN FLOW OUT FLOW

RECIRCULATE

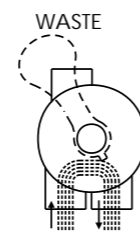

IN FLOW OUT FLOW

**GENERAL**

- 1) Pipe tap boss provided for optional influent pressure gauge.
- 2) SERVICING VALVE ( Stop pump, close gate valve in suction & discharge before proceeding):
  - a) Set handle in filter position.
  - b) Remove cover screws.
  - c) Lift cover and key assembly out.

**TO ASSEMBLE:**

- 1) Place valve key so that wedge opening is at TOP port (handle in Filter psn.). Flat edge of cover screw lug should align with flat edge of body screw lug.
- 2) Position cover O'Ring.
- 3) Secure assembly to body with cover screws. Tighten cover screws evenly and alternately. Do not over-tighten.

**WARNING**

- ⚠ THIS FILTER OPERATES UNDER HIGH PRESSURE. WHEN ANY PART OF THE CIRCULATING SYSTEM (e.g., CLAMP, PUMP, FILTER, VALVES, ETC.) IS SERVICED, AIR CAN ENTER THE SYSTEM AND BECOME PRESSURIZED. PRESSURIZED AIR CAN CAUSE THE LID OR VALVE TO BE BLOWN OFF WHICH CAN RESULT IN SEVERE INJURY, DEATH, OR PROPERTY DAMAGE.
- ⚠ TURN PUMP OFF BEFORE CHANGING VALVE POSITION.
- ⚠ TO PREVENT DAMAGE TO THE PUMP AND FOR PROPER OPERATION OF THE SYSTEM, CLEAN PUMP STRAINER AND SKIMMER BASKETS REGULARLY.
- ⚠ DO NOT UNSCREW SCREWS OF FLANGE CLAMP WHILE PUMP IS RUNNING.
- ⚠ UNDER LOW TEMPERATURE SHUT OFF CONDITION, IT IS STRONGLY RECOMMEND TO TURN TO WINTERISE POSITION AND DISCHARGE ALL THE WATER INSIDE FILTER THROUGH THE BOTTOM DRAIN.

Models: V700(B) / V800 / V900 / V1000 / V1200  
(Link by Nuts type Valves)

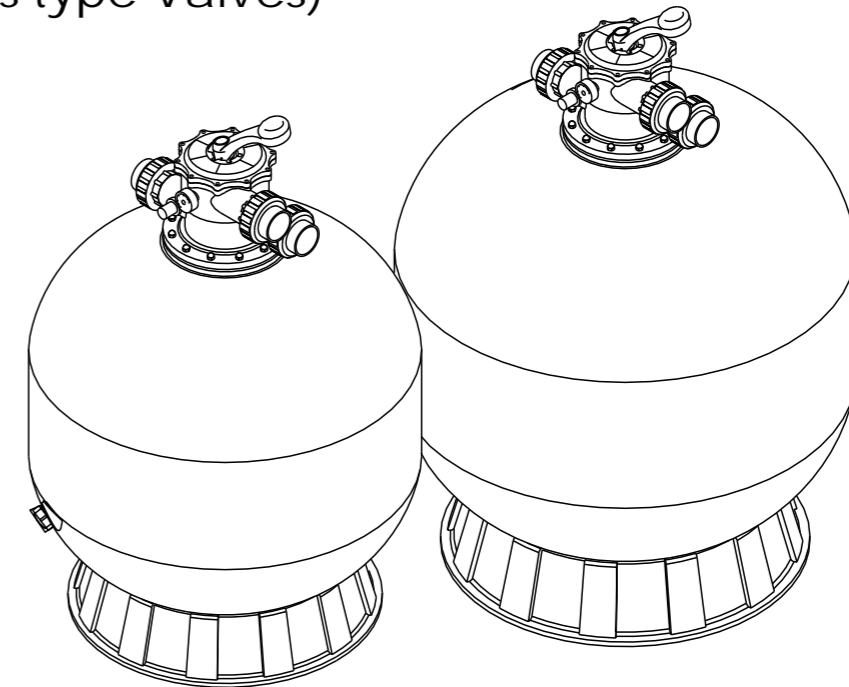

**FUNCTION**

The filter uses special filter sand to remove dirt particles from pool water. The filter sand is loaded into the filter tank and functions as a permanent dirt removing media. When the control valve is in the FILTER position, the pool water which contains suspended dirt particles, is pumped through your piping system and is automatically directed by the patented filter control valve to the top of the filter tank. As the pool water is pumped through the filter, dirt particles are trapped by the sand bed, and filtered out. The cleaned pool water is returned from the bottom of the filter tank, through the control valve and back to the pool through the piping system. This entire sequence is continuous and automatic. It provides for total recirculation of pool water through your filter and piping system.

After a period of time, the accumulated dirt in the filter causes a resistance to flow, and the flow diminishes. This means it is time to clean your filter. With the control valve in the BACKWASH position, the water flow is automatically reversed through the filter so that it is directed to the bottom of the tank, up through the sand, flushing the previously trapped dirt and debris out the waste line. Once the filter is back-washed of dirt, set control valve to RINSE position and run pump for about 1/2 to 1 minute, and then set the control valve in the FILTER position, to resume normal filtering.

NOTE: Turn pump off before changing valve position.

**INSTALLATION**

Only simple tools (screwdriver and wrenches), plus pipe sealant for plastic adapters, are required to install and service the filter.

- 1) The filters should be placed on a level concrete slab, very firm ground, or equivalent. The filters should be placed
- 2) Loading the sand media. Filter sand media is loaded through the top opening of the filter.
  - a) Loosen the flange clamp and remove filter control valve (if previously installed).
  - b) Cap internal pipe with plastic cap to prevent sand from entering it.
  - c) We recommend filling the tank approximately 1/2 way with water to provide a cushion effect when the filter sand is poured in. This helps protect the under-drain laterals from excessive shock.
  - d) Carefully pour in correct amount and grade of filter sand. (Be sure center pipe remains centered in opening.) Sand surface should be leveled and should come to about the middle of the filter tank. Remove plastic cap from internal pipe.

- 3) Assemble filter control valve into the filter tank.
  - a) Insert filter control valve (with O'ring in place) into the tank neck, taking care that the center pipe slips into the hole in the bottom of the valve.
  - b) Place two plastic clamps around valve flange and tank flange and tighten just enough so that the valve may be rotated on tank for final positioning.
  - c) Carefully screw pressure gauge (with O'ring in place) into tapped hole in valve body. Do not over-tighten.
  - d) Connect pump to control valve opening marked PUMP. After connections are made, tighten valve flange clamps with screwdriver, tapping around clamp with screwdriver handle to help seat valve flange clamp.
- 4) Make return to pool pipe connection to control valve opening marked RETURN and complete other necessary plumbing connections, suction lines to pump, waste, etc.
- 5) Make electrical connections to pump per pump instructions.
- 6) To prevent water leakage, make sure all pipe connections are tight.

### MAIN DIMENSION

DIMENSION TABLE

Model	Height A mm	Diameter B mm	Valve Port Size Inch	Sand kg
V700(B)	1092	723	2"	215
V800	1200	800	2"	355
V900	1300	900	2"	470
V1000	1400	1000	2"	620
V1200	1600	1200	2"	860

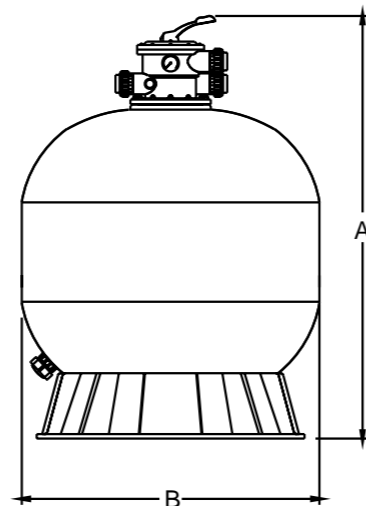

### INSTALL/START-UP OF FILTER

- 1) Make sure the correct amount of filter media sand is located in the tank and all connections have been connected and secured.
- 2) Depress control valve handle and rotate to BACKWASH position. (To prevent damage to control valve seal, always depress handle before turning.)
- 3) Prime and start pump according to pump instructions (be sure all suction and return lines are open), allowing the filter tank to fill with water. Once water is flowing out of the waste line, run the pump for at least 1 minute. The initial back-washing of the filter is recommended to remove any impurities or fine sand particles in the sand media.
- 4) Turn pump off and set valve to RINSE position. Start pump and operate until water in sight glass is clear, about 1/2 to 1 minute. Turn pump off and set valve to FILTER position and restart pump. The filter is now operating in the normal filter mode, filtering dirt particles from the pool water.
- 5) Adjust pool suction and return valves to achieve desired flow. Check system and filter for water leaks and tighten connections, bolts, nuts, as required.
- 6) Note the initial pressure gauge reading when the filter is clean. (It will vary from pool to pool depending upon the pump and general piping system.) As the filter removes dirt and impurities from the pool water, the accumulation of dirt in the filter will cause the pressure to rise and diminish the water flow. When the pressure gauge reading is 1.5 bar, higher than the initial "clean" pressure you noted, it is time to backwash the filter (see BACKWASH under filter and control valve functions).

NOTE: During initial clean-up of the pool water it may be necessary to backwash frequently due to the unusually heavy initial dirt load in the water.

### REPLACEMENT PARTS OF FILTER

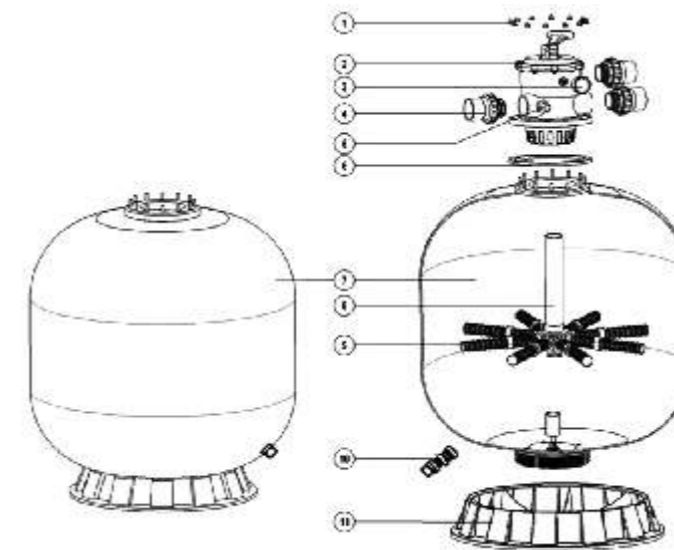

Notes: 9" 01172010 Laterals (185mm) for V700B  
 9" 01172011 Laterals (233mm) for V800 & V900  
 9" 89010613 Laterals (129mm & 185mm) for V1000  
 9" 89010614 Laterals (129mm & 233mm) for V1200

Item	Part No.	Description	Qty
1	89010601	Nut with Washer	12
2	88280351B	6 Way 2" Valve with 2" union set x 3 and pressure gauge (Black)	1
3	06011029	Oil Pressure Gauge With O ring 40psi	1
	06011030	Oil Pressure Gauge With O ring 60psi	
4	89280103B	2.0" Union with O-Ring (Black)	3
5	89280104	Sight Glass with O-Ring	1
6	02011126	Filter Neck Gasket	1
7	89010612	V700B Filter Tank with Base	1
7	89010603	V800 Filter Tank with Base	1
7	89010604	V900 Filter Tank with Base	1
7	89010605	V1000 Filter Tank with Base	1
7	89010606	V1200 Filter Tank with Base	1
8	89010611	V700B Standpipe with hub	1
8	89010607	V800 Standpipe with Hub	1
8	89010608	V900 Standpipe with Hub	1
8	89010609	V1000 Standpipe with Hub	1
8	89010610	V1200 Standpipe with Hub	1
9	01172010	Laterals (185mm)	8
9	01172011	Laterals (233mm)	8
9	89010613	Laterals (129mm & 185mm)	8
9	89010614	Laterals (129mm & 233mm)	8
10	89010107	Water Drain Set	1
11	01111062	21-28inch Filter Base	1
11	01112038	32-40 inch Filter Base	1
11	01112039	Base for V1200	1

### REPLACEMENT PARTS OF MULTIPOINT VALVE

Item	Part No .	Product Description	Qty
1	01013003	Handle B(g )	1
2	03018008	Pin for Handle	1
3	01181027	Washer for Handle	1
4	89280301	M6 *32 Screw with Nut	10
5	01013019	2 0 "Top Mount Valve Standard Lid B(ack )	1
6	03014014	Spring for 2 0 "Top Mount Valve	1
7	02011006	O -Ring for 2 0 "Top Mount Valve Lid	1
8	02011022	O -Ring for 2 0 "Top Mount Valve Rotor	2
9	01181002	Washer for Spring	2
10	01021002	2 0 "Valve Rotor	1
11	02311003	Spider Gasket	1
12	01013027	2 0 "Top Mount Valve Bottom Body b(ack )	1
13	01013029	2 0 "Water Tube	1
14	01013030	2 0 "Diffuser	1
15	02011005	O -Ring for Diffuser	1
16	02020016	O -Ring for Connector	6
17	01013031	2 0 "Connector with External Thread B(ack )	3
18	01171154	2 0 "Union Adaptor	3
19	01013032	2 0 "Union Nut B(ack )	3
20	89280104	Sight Glass with O -Ring	1
21	01111048	Connector for Pressure Gauge Stopper	1
22	89021303	Drain Plug with O ring	1
23	06011029	Oil Pressure Gauge With O ring 40psi )	1
	06011030	Oil Pressure Gauge With O ring 60psi )	

